



# SILCA DOMESTIC FIREPLACES AND CHIMNEYS



## **INNOVATIVE SOLUTIONS TO MEET STRINGENT REQUIREMENTS IN FURNACE CONSTRUCTION**

SILCA is the international service and sales company of the Calsitherm Group, specializing in high-temperature materials and lightweight thermal insulation in various applications. As the only German manufacturer of calcium silicate, we have demonstrated in the past years that through innovative products both safety and productivity during installation of fireplaces may further be improved. This is guaranteed by means of close cooperation with specialist tradesmen and retailers as well as through the wealth of experience that SILCA GmbH has been able to gain over the years, not least in insulation in the industrial sector.





The range of specially manufactured calcium silicate boards and the corresponding system components from SILCA GmbH is as diverse as the construction and requirements of fireplaces. **SILCA® 250KM** and **SILCAHEAT® 600C** are calcium silicate boards established and used worldwide with many certificates and approvals. **SILCA® 250KM** is used both as an insulation board for the protection of adjoining walls and as construction board. The German Construction Institute in Berlin (DIBt) has issued the General Construction Technique Permit (aBG) Approval No. Z-43.14-117. The excellent measurement results for determining the equivalent thickness according to the technical rules of the Tiled Stove and Air Heating Constructors Association can be found in the following diagrams. The construction board for fireplaces **SILCAHEAT® 600C** enables pleasant thermal radiation, thanks to a precisely defined graphite content in the formula. The desire for a comfortable surface heat of the fireplace is combined here at the same time with a simple and versatile installation option.

Development and research as well as constant exchange with our customers enable us to continuously develop the application of calcium silicate materials. In addition to the options for using lightweight shafts, SILCA offers the **SILCAPAN 750FB**, a fixed combustion chamber board, for using directly in the combustion chamber of a fireplace. By means of its properties **SILCAPAN 750FB** optimises the combustion process, reduces emissions and proves itself with its high stability and resistance to moisture directly in the firing.

The construction board **SILCARAPID® 850CB** is also part of the product range for construction of fireplaces. The new system solution **SILCARAPID®** expands the present SILCA product range with a lightweight, simple and above all, quick to assemble calcium silicate board with a smooth and solid surface. Subsequent time-consuming plastering is not necessary with **SILCARAPID® 850CB**.

You can find information on this new type of construction board for the construction of fireplaces in the special brochure **SILCARAPID® 850CB**.

The main ingredients of the SILCA calcium silicate boards are lime and sand. They are classified as physiologically harmless and environment friendly construction products. This is ensured by modern production facilities, ongoing quality controls, external monitoring and certification according to DIN EN ISO 9001: 2015. The environmental compatibility is confirmed by means of environmental product declaration according to ISO 14025 and EN 15804 issued by the Institute for Construction and Environment Inc. (Declaration number EPD-CSP 20180010-IBC1-DE).



## SILCA® 250KM

**SILCA® 250KM** is a true European champion. In addition to the Swiss Fire Safety Certificate No. 15202 from the Association of Cantonal Fire Insurance Companies (VKF), Certificate No. 120-0238 from Scandinavia's largest independent Research Institute, RISE FR has been issued. Obviously, the values required by the OE Norm B8311 (Installation and construction of domestic heat generating systems) have been achieved. Internationally, this means safety and trouble-free delight for construction and heating of domestic fireplaces. **SILCA® 250KM** has been certified according to the standard EN 14306:2009+A1:2013, (No. 0432-CPR-00697-01).

**SILCA® 250KM** combines brickwork and thermal insulation into one construction material and guarantees therefore not merely better values than comparable products. The required technical

rules TR-OL (Stove and Air Heating Constructors Association) and further national regulations are provided in the respective diagrams. Depending on the application, active rear ventilation may have to be provided.

In addition to standard sizes, cuts can be made directly in the factory upon request. **SILCA® 250KM** can be processed with standard wood machining tools. It is also possible to use screws during installation.

The calcium silicate board has been awarded the environmental product declaration by the Institute for Construction and Environment Inc. (IBU) in accordance with ISO 14025 and EN 15804. **SILCA® 250KM** can be disposed of as construction waste in accordance with European Waste Catalogue (EAK) code 170101.



### SPECIAL PROPERTIES OF SILCA 250KM

- Space utilisation due to less insulation thickness
- Non-flammable
- Environmental-friendly construction product
- Physiologically harmless
- Brickwork and thermal insulation in one building material
- Large size boards
- Easy handling and treatment
- Problem-free disposal as construction rubble
- Can be used as insulation and construction board

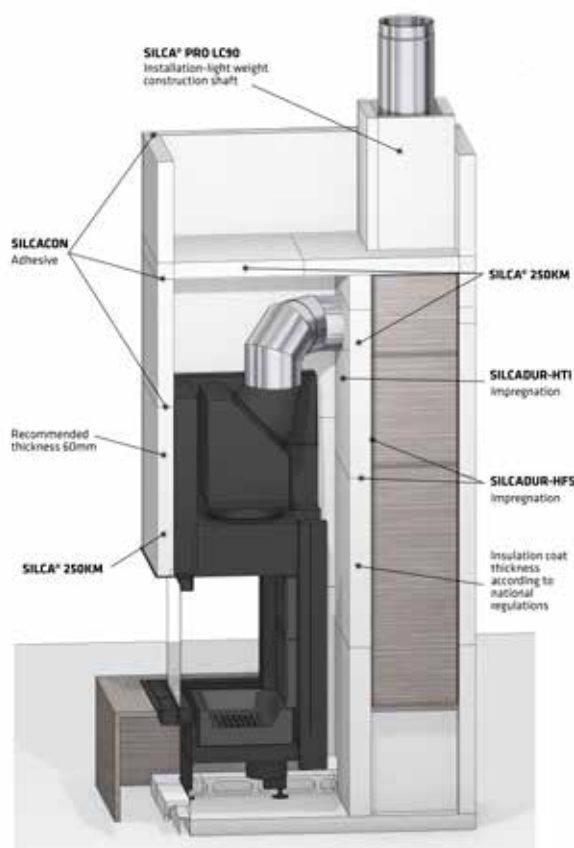

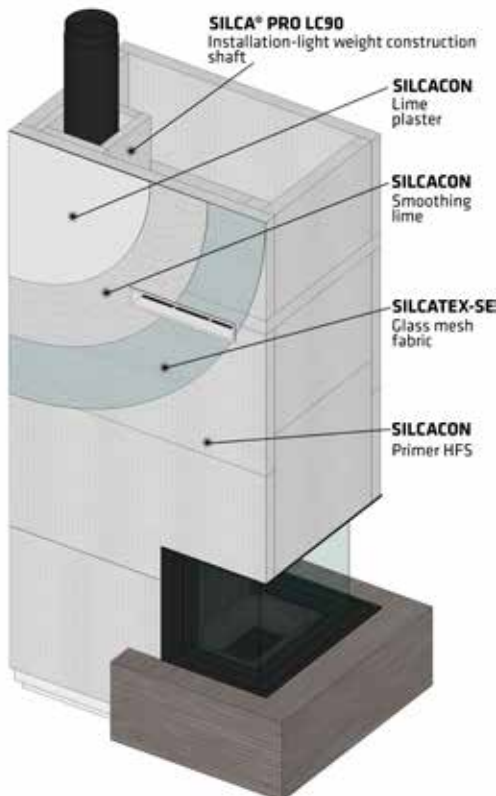

Technical data SILCA® 250KM	
Approved for Germany	General Construction Technique Permit
Approved for Switzerland	No. Z-43.14-117
RISE FR Certification	Fire Safety Certificate No. 15202
CE Certificate	120-0238 (50mm)
Fire performance	0432 CPR-00697-01
Bulk density (± 10%)	Euro class A1
Porosity	250 kg/m <sup>3</sup>
Compressive strength	Approx. 90 %
Heat transmission resistance at 40 mm board thickness	> 1.4 MPa
Thermal conductivity λ at 200 °C	≥ 0.5 m <sup>2</sup> K/W
Thermal expansion at 500 °C	< 0.1 W/m K
Standard size in mm	0.2 %
Standard thickness in mm	3,000x1,250, 2,000x1,250, 1,500x1,250, 1,500x1,250, 1,250x500, 1,000x625, 625x500
	30-100

The properties mentioned are typical values from series tests, which were determined according to recognised test methods. Material and product-specific variations must be taken into account. The information does not indicate assured properties and cannot be used for a guarantee. We reserve the right to make technical changes.

**For using in accordance with the technical rules of the Tiled Stove and Air Heating Constructors Association**

**a) As a replacement for thermal insulation level WDS 1-2**

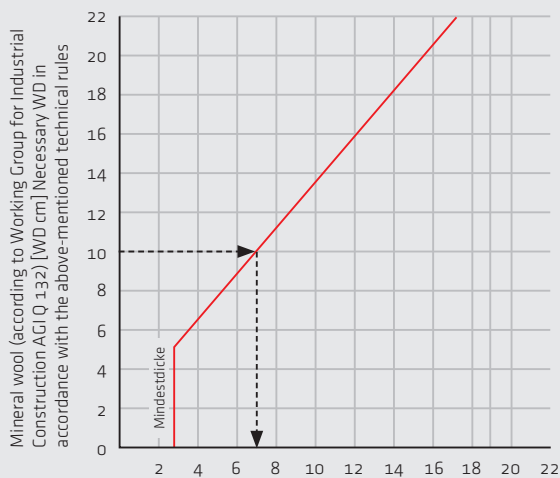

Example:  
Necessary thermal insulation (WD) with mineral wool (according to Working Group for Industrial Construction AGI Q 132) as per manufacturer's specification: 10 cm

**Corresponds to 7.3 cm SILCA® 250KM**

**b) As a replacement for brickwork and thermal insulation level WDS 3-4**

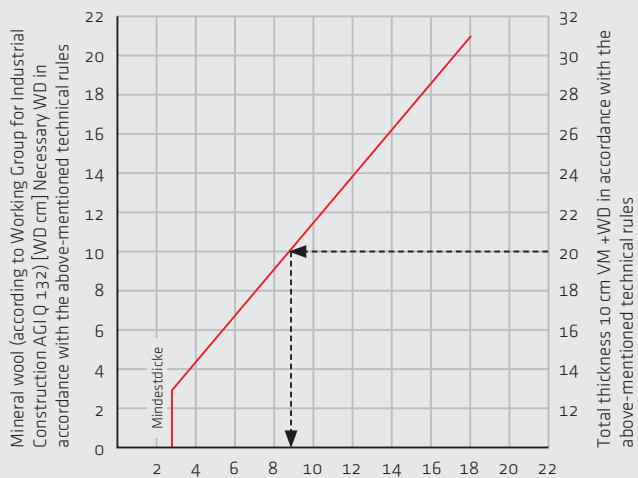

Example:  
Necessary thermal insulation (WD) with mineral wool (According to Working Group for Industrial Construction AGI Q 132) as per manufacturer's specification: 10 CM  
Necessary brickwork (VM) in accordance with technical rules: 10 cm  
Total thickness according to DIN 18892: 20CM

**Corresponds to 8.9 cm SILCA® 250KM**

## SILCAHEAT® 600C

**SILCAHEAT® 600C** is a high temperature resistant hybrid material composed of calcium silicate and carbon. The high graphite content provides excellent heat conducting properties to the construction board while using for lining the fireplaces. **SILCAHEAT® 600C** is not an insulation board! **SILCAHEAT® 600C** meets the requirements of the technical rules in the Stove and Air Heating Construction TR-OL, according to section 3.1 as substance / construction material and component in the heating chamber or convection chamber. **SILCAHEAT® 600C** meets the requirements in accordance with DIN EN 14306 n.

SILCA® 250KM Calcium silicate insulation boards have proven their worth when used as insulation for adjoining areas, but also as a construction board for domestic fireplaces. The easy and quick handling of calcium silicate board enables a safe and economical installation of the fireplace. The design options are almost unlimited. Only the high quality of the insulation board brings natural restrictions in terms of heat radiation to the room where the furnace is installed.

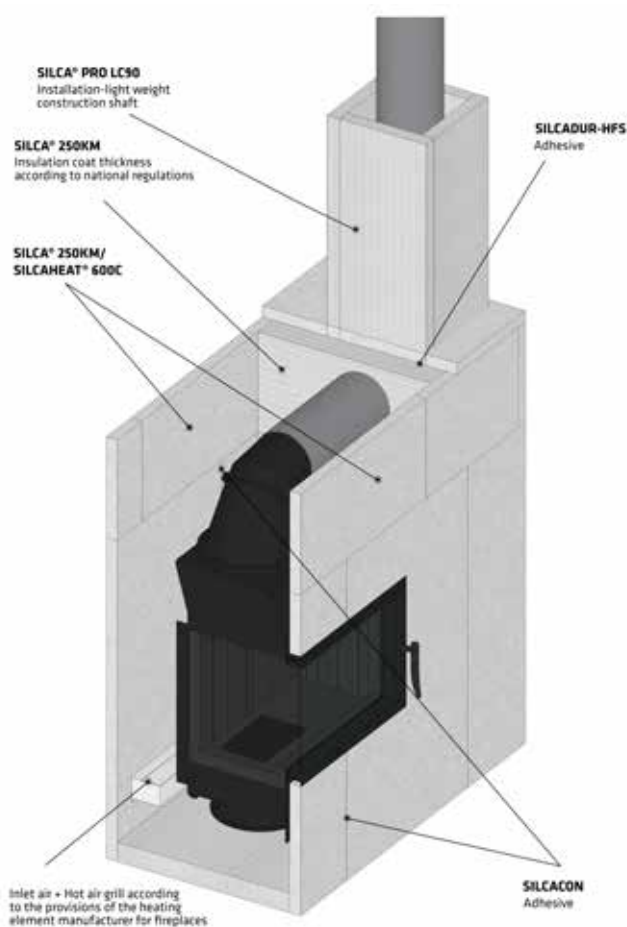

The product innovation from SILCA shows that: our customers' desires and suggestions could be realised and even surpassed. Our many years of experience as the only German manufacturer of calcium silicate boards for the application in domestic fireplaces enabled us to develop the construction board for fireplaces **SILCAHEAT® 600C**. The European Patent Office issued patent number EP251634781 for our innovation. **SILCAHEAT® 600C** is certified by the Materials Testing Office of North Rhine Westphalia (NRW).

The processing of **SILCAHEAT® 600C** is easy, fast and safe. The solid self-supporting construction boards for fireplaces can be treated with standard wood machining tools. **SILCACON Adhesive** is used for bonding. Countersunk screws can be used without pre-drilling, this extends the possibilities of installation many times over. According to customers' desires **SILCAHEAT® 600C** construction boards for fireplaces may be plastered or decorated with natural stone or stove tiles after installation.

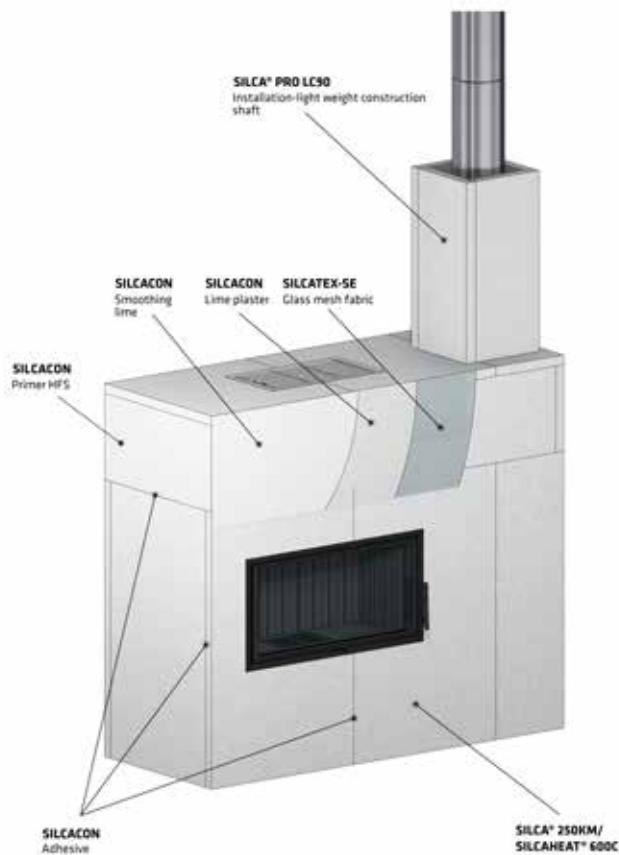

**SPECIAL PROPERTIES**

- Extremely light, optimal strength
- Good storage capacity, very good dimensional accuracy
- Good radiation properties, extremely low thermal expansion
- Non-flammable
- Self-supporting and dimensionally stable, not soluble in water - suitable for wet and dry cutting, installation with adhesive and/or screws
- Huge time-saver when building an optimal material compound with SILCA® 250KM
- Environment-friendly

**SILCACON Plaster** and **SILCACON Smoothing lime** can be used for plastering of **SILCAHEAT® 600C** construction board for fireplaces. The plaster is reinforced with heat-resistant **SILCATEX-SE Glass mesh fabric**.

**SILCAHEAT® 600C** is a newest generation construction board for fireplaces. Can be used up to 1000°C, it impresses with its low weight, high compressive strength and excellent edge stability. The radiant heat is pleasantly and homogeneously emitted in the installation room. **SILCAHEAT® 600C** is resistant to thermal shock, can be processed precisely and, despite its good thermal conductivity, has only a very low thermal expansion. Of course, the construction board for fireplaces is asbestos-free. Scraps and leftovers can be disposed of as construction waste.

Technical data SILCAHEAT® 600C	
Product norm	DIN EN 14306
CE Certificate	0432-CPR-00697-01
Bulk density	650 kg/m <sup>3</sup>
Fire performance	Euro class A1
Application temperature	1,000°C
Compressive strength	7.0 MPa
Flexural strength	3.0 MPa
Thermal expansion at 500 °C	-0.03%
Standard size in mm	1000x625; 1250x500;
Standard thickness in mm	1250x1000
	25 and 35

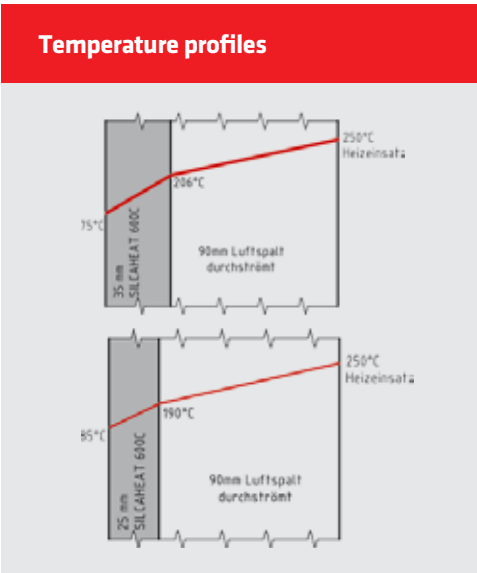



## ACCESSORIES

**SILCA® 250KM**, **SILCAHEAT® 600C** and the new construction board **SILCARAPID® 850CB** enable quick, easy and safe cladding of fireplaces. The various SILCA calcium silicate boards offer optimal system solutions for the most varied types of fireplaces. For erection and installation, the information provided by the heating element manufacturer and the legal requirements for construction of fireplaces must be observed. According to customer's request, SILCA calcium silicate boards can then be constructed further with SILCACON putty compound,

SILCACON brush-on plaster, SILCACON plaster/smoothing lime or ceramic coatings/natural stone. SILCACON system consists of various complementary components. This means that the widest variety of requirements regarding appearance of the surface can be implemented.

**SILCACON – simple, fast and safe lining for modern fireplaces! – now also with SILCACON putty compound and SILCACON brush-on plaster.**





## SILCACON Adhesive

**SILCACON Adhesive** is a high-quality hydraulically hardening adhesive mortar that is ready to use after mixing with water. It is a premixed, hydraulic-setting dry mortar with cement according to DIN 1164 and with high-quality fillers / additives that is mixed with clean water. It serves to bond **SILCA® 250KM** insulation boards and **SILCAHEAT® 600C** construction boards for furnaces for applying in the area of structural use on the exterior of fireplaces and tiled stoves.

Please make absolutely sure that SILCACON adhesive is never used for the treatment of SILCA® 250KM boards on the interior of the furnace (for the required fire and heat protection of the wall to be protected). Instead, our SILCADUR HFS adhesive, which is officially approved, should be applied.

SILCACON adhesive can also be used on all mineral wall materials and substrates that are suitable for plastering, such as masonry made out of construction materials with hydraulically hardening binding agents according to DIN 1164, DIN 1060, DIN 4211 as well as masonry with natural, standardised or officially approved construction materials according to DIN 1053 (for example, aerated concrete, clay brick and sand-lime brick).



## SILCACON Primer HFS

**SILCACON Primer HFS** is offered with a newly revised formulation for surface treatment of **SILCA® 250KM**, **SILCAHEAT® 600C** and **SILCARAPID® 850CB**. The new primer reduces the capillary activity of the mentioned calcium silicate boards and strengthens the surface. This enables improved further processing with SILCACON adhesive, SILCACON putty compound, SILCACON brush-on plaster and SILCACON plaster/smoothing lime. SILCACON primer HFS is mixed with clean water in a ratio of up to 1:2 and can be applied with a brush, roller or sprayer. SILCACON primer HFS is permeable and alkali-resistant. The new formulation guarantees thermal stability on the outside of the calcium silicate surfaces. It is available in 1 litre bottles and 5 litre canisters.



## SILCACON Lime plaster – natural white

**SILCACON Lime plaster** has a grain diameter of 0 - 1.2 mm and is applied to the surface of the boards that have been pre-treated with SILCACON and dried. For board joints or as general reinforcement, we recommend incorporating SILCATEX-SE glass mesh fabric. The lime plaster can be applied in one or two work steps. The first coat of plaster should be in the range of approx. 5 – 10 mm. The total thickness of the coats should be a maximum of 15 mm.



## SILCACON Smoothing lime – natural white

**SILCACON Smoothing lime** can be applied either directly upon the primed SILCA® 250KM or SILCAHEAT® 600C boards or as last coat upon the lime plaster in order to smoothen the surface. The maximum thickness of the coat is 1 mm and is limited to a total thickness of 2 mm according to the test certificate issued by authorities. For details on finishing of SILCACON products, please refer to our corresponding processing instructions on the containers.



## SILCADUR-HTI impregnation

**SILCADUR-HTI** is a high-temperature resistant impregnation tailored for application on our calcium silicate products. It serves to strengthen the surface and bind dust. The impregnation is inorganic, odour-neutral and suitable for additional surface treatment of SILCA® 250KM boards in the heating chamber. The impregnation is not suitable as primer for subsequent plastering and bonding in the construction area – SILCACON primer HFS should be applied for this purpose. The processing is very easy, SILCADUR-HTI is ready to use and is applied with a brush or sprayer.





## SILCATEX-SE Glass mesh fabric

**SILCATEX-SE Glass mesh fabric** is an e-glass with special finish for low flammability and slip resistance. It serves to reinforce the plaster and concrete putty. It is alkali-resistant, dimensionally stable, and rot-proof. It does not contain any corrosive or irritant substances

### Product details

Classification temperature	550 °C
Decomposition of the blackwash	> 350 °C
Surface weight	approx. 165 g/m <sup>2</sup>
Mesh width	4 x 4 mm
Roll dimension	50 x 1 / 10 x 1 m

The properties mentioned are typical values from series tests, which were determined according to recognised test methods. Material and product-specific variations must be taken into account. The information does not indicate assured properties and cannot be used for a guarantee. We reserve the right to make technical changes.



## SILCAWOOL

**SILCAWOOL** is a high temperature fibre with an increased bio-solubility and is therefore an alternative to the well-known aluminium silicate wool (ceramic fibre). It is made of spun fibres based on calcium magnesium silicate. They are characterised by high thermal stability, high tensile strength as well as good elasticity. Due to the high bio-solubility, they are not classified as dangerous material.

## SILCAWOOL Fibres

**SILCAWOOL Fibres** are finished into mats, boards, paper and cords or delivered as loose wool..



## SILCAWOOL 120 Paper

SILCAWOOL 120 Paper contains an acrylic bonding agent. Apart from the standard products, we also deliver ready-cut strips with an organic self-adhesive film on one side for easy installation. These strips are primarily used as elastic separator between the refractory material and the metallic built-in components, such as, support frames.



### Product details

SILCAWOOL 120 paper	1,000 x 10,000 x 3
Standard size in mm	1,000 x 10,000 x 4 1,000 x 10,000 x 5
Strip size in mm (self-adhesive)	10,000 x 50 x 5 10,000 x 35 x 5 (Other sizes possible upon request)

The properties mentioned are typical values from series tests, which were determined according to recognised test methods. Material and product-specific variations must be taken into account. The information does not indicate assured properties and cannot be used for a guarantee. We reserve the right to make technical changes.



## SILCAWOOL 120P Bio-soluble mats and strips

SILCAWOOL Mats are characterised by good tensile strength, are sewed on both sides and have no organic bonding materials, which can cause unpleasant odour. They provide a certain amount of elasticity, for example, as expansion gap between hot gas flues and tiled wall or other movable components.

### Product details

Classification temperature		1,200 °C
Bulk density (± 10 %)		128 kg/m <sup>3</sup>
Mats	Size in mm	14,640 x 610 x 13
		7,320 x 610 x 25
		5,500 x 610 x 6
Strips	Size in mm	5,500 x 50 x 6

The properties mentioned are typical values from series tests, which were determined according to recognised test methods. Material and product-specific variations must be taken into account. The information does not indicate assured properties and cannot be used for a guarantee. We reserve the right to make technical changes.





## SILCAWOOL AST

SILCAWOOL AST are fittings for chimneys made of bio-soluble SILCAWOOL fibre. Due to their special shape, the fittings adapt perfectly to the inner fireclay pipe in the chimney and can also be easily processed with the cutter knife. The enlarged opening on the side of the furnace enables the introduction of a double wall lining. Installation takes place in consultation with the responsible Master chimney sweep.



Product details			
Classification temperature		°C	1,100
Continuous application temperature (max.)		°C	950
Bulk density		kg/m <sup>3</sup>	350
Colour			Beige
Linear shrinkage after 24 h at	1000 °C	%	1.5
	1100 °C		< 3.0
Average specific heat capacity	20 – 1000 °C	kJ/ (kg K)	1.04
Thermal conductivity at tm	400 °C	W/ (m K)	0.20
	600 °C		0.25
	800 °C		0.29
	1000 °C		0.32
Chemical analysis guidance value	Al <sub>2</sub> O <sub>3</sub>	%	10*
	SiO <sub>2</sub>		61
	Fe <sub>2</sub> O <sub>3</sub>		< 0.5
	CaO		25
	MgO		3
Flue pipe connector dimensions	for Ø 150 mm	mm	100 x Øi160 x Øa200
	for Ø 160 mm		100 x Øi170 x Øa210
	for Ø 180 mm		100 x Øi190 x Øa230
	for Ø 200 mm		100 x Øi210 x Øa250

\* This aluminium oxide content is only present in the binding agent and filler materials, i.e., not in the SILCAWOOL woollens.

The properties mentioned are typical values from series tests, which were determined according to recognised test methods. Material and product-specific variations must be taken into account. The information does not indicate assured properties and cannot be used for a guarantee. We reserve the right to make technical changes.



## **SILCAPAN 750FB /SILCAPAN 750FBG Combustion chamber board**

SILCAPAN 750FB consists of natural raw materials without added bonding agents. The bright reflecting surface and good insulating properties make it possible to rapidly achieve the steady-state temperature in the combustion chamber of a fireplace. Along with the outstanding insulating properties, the combustion chamber board also offers convincing features such as high compressive and flexural strength. With our modern five-axis CNC machines, we process SILCAPAN 750FB according to your requirements or just offer standard sizes.

NEW! We also offer the SILCAPAN 750FBG combustion chamber board in a dark grey version. The combustion chamber board is fully coloured and remains colour-fast even under high thermal loads. SILCAPAN 750FBG thus also visually extends the technical advantages of the combustion chamber board.



SILCAPAN 750FB-G



SILCAPAN 750FB



**SPECIAL PROPERTIES**

- High compressive and flexural strength Low thermal conductivity
- Bright, reflective surface
- Reduces emissions
- Insensitive to moisture

SILCAPAN 750FB	Standard	Unit	Value
CE Certificate	0432-CPR-00697-01		
Bulk density (+-10%)	EN 1602	kg/m <sup>3</sup>	850
Upper application limit temperature	EN 1095-6	°C	1050
Thermal conductivity	EN 12667	W/(mK)	0.21
Cold compressive strength	EN 826	MPa	12
Flexural strength	EN 12089	MPa	7
Hardness	DIN 53505	Shore D	62



The properties mentioned are typical values from series tests, which were determined according to recognised test methods. Material and product-specific variations must be taken into account. The information does not indicate assured properties and cannot be used for a guarantee. We reserve the right to make technical changes.

## SILCADUR HFS Adhesive



SILCADUR-HFS Adhesive should be used as bonding material for SILCA® 250KM boards. The adhesive is available ready-to-use in buckets or tubular sacs and can be applied directly after stirring or kneading. Further details regarding handling, storage etc., can be taken from our bonding instructions on the corresponding packaging of the boards.

### Product details

Classification temperature	950 °C
Package size	Bucket 6.5 kg, Tubular sac 700 g, 900 g
Frost-free storage in closed package	18 months
Handling temperature	10 – 25 °C

The properties mentioned are typical values from series tests, which were determined according to recognised test methods. Material and product-specific variations must be taken into account. The information does not indicate assured properties and cannot be used for a guarantee. We reserve the right to make technical changes.

## SILCADUR CSMH Adhesive



SILCADUR-CSMH is a repair adhesive with an inorganic base and a classification temperature of 1,300 °C. It is used for bonding of dense calcium silicates or other mineral construction materials one below the other as well as for repairing cracks, fractures, etc., in fireclay and vermiculite products within the fireplace.

The drying time depends on the thickness of the coat and the environment (temperature, humidity). In general, the drying time should be at least 24 hours and the subsequent heating-up has to be done slowly. In case the adhesive is not completely hardened, steam bubbles may appear while heating-up. SILCADUR-CSMH adhesive is available in resealable cans of 500 ml and in cartridges of 310 ml.





## SILCASIL 320 High temperature silicone adhesive



SILCASIL 320 has an excellent adhesive strength and a high temperature resistance up to 320 °C. It is used for sealing and bonding, for example, for bonding of cords or tapes. It can be applied on most firm, clean and dust-free surfaces, for example, metal, ceramics or mineral construction materials. Exposure to high temperature is only permitted after complete hardening of SILCASIL 320. Based on customer requests, SILCASIL 320 is now available in **black** colour.

Product details	
Temperature resistance	Max. 320 °C (1,000 h)
Thickness at 20 °C	1.15 g/cm <sup>3</sup>
Hardness	20 Shore A
Handling temperature	5 - 40 °C
Film formation of the surface	after 10 minutes
Hardening, coat thickness 3 mm	after 24 h
Colour	Black
Delivery forms	290 ml cartridges

The properties mentioned are typical values from series tests, which were determined according to recognised test methods. Material and product-specific variations must be taken into account. The information does not indicate assured properties and cannot be used for a guarantee. We reserve the right to make technical changes.



## **SILCA: MORE THAN 30 YEARS OF KNOW-HOW AND INNOVATION**

SILCA is the international service and sales company of the Calsitherm Group, specializing in high temperature materials and lightweight thermal insulation in various applications.

As the only German manufacturer of calcium silicate, we have demonstrated in the past years that through innovative products both safety and productivity during installation of fireplaces may continuously be improved. From A for aluminium casting to D for domestic fireplaces and chimneys to H for heat treatment systems, we cover all areas of refractory technologies in a wide variety of industries. In addition to the delivery of materials, we offer an integral service for technical questions and developments. This includes consulting, engineering, material delivery and complete services including installation of high-temperature systems.



[www.silca-online.de](http://www.silca-online.de)

With our companies SILCA Italia, SILCA Insulation (SEA) Malaysia, SILCA South Africa, SILCA Mexico as well as SILCA Amsterdam and International Syalons, we are active worldwide.

Consistent quality requires the systematic co-operation of all parties involved in the processes of production, sales and application. This is how we develop high-performance products that meet the high quality requirements of our customers. By doing so, we build on a know-how that has grown over more than 30 years and thus portray the basis for quality and innovation.

The key factors of our success are the high quality of our products, the high level of customer satisfaction and motivated and qualified employees.

**SILCA is a member of**



GesamtVerband OfenBau



**Your local specialist dealer**

**silca**  
refractory solutions

**SILCA Service and Sales Company for Insulation Materials mbH**

Elberfelder Street 200 a, 40822 Mettmann

Telephone: +49 2104 9727-0 | Fax: +49 2104 76902 | [info@silca-online.de](mailto:info@silca-online.de) | [www.silca-online.de](http://www.silca-online.de)

